

OPTICS ACCESS CHAMBER ZK2 VENKON

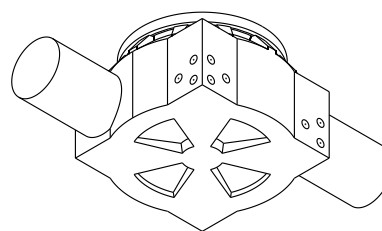

- Optics access chambers are used for telecommunication network for installation of continued or transmission cable reserve.
- They are used for mechanical protection cable reserve.
- They serve as buses, branching points and connect any telecommunication cables.

Type	Cable reserve	Weight	Backfill
ZK2 VENKON	- for 8 mm diameter - 300 m - for 8-12 mm diameter - 200 m - for 12-15 mm diameter - 100 m	22 kg	0,7 - 1,47 m

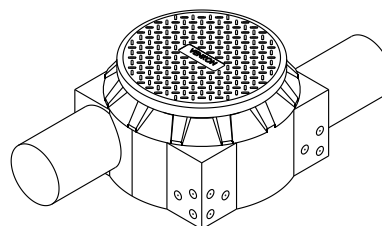
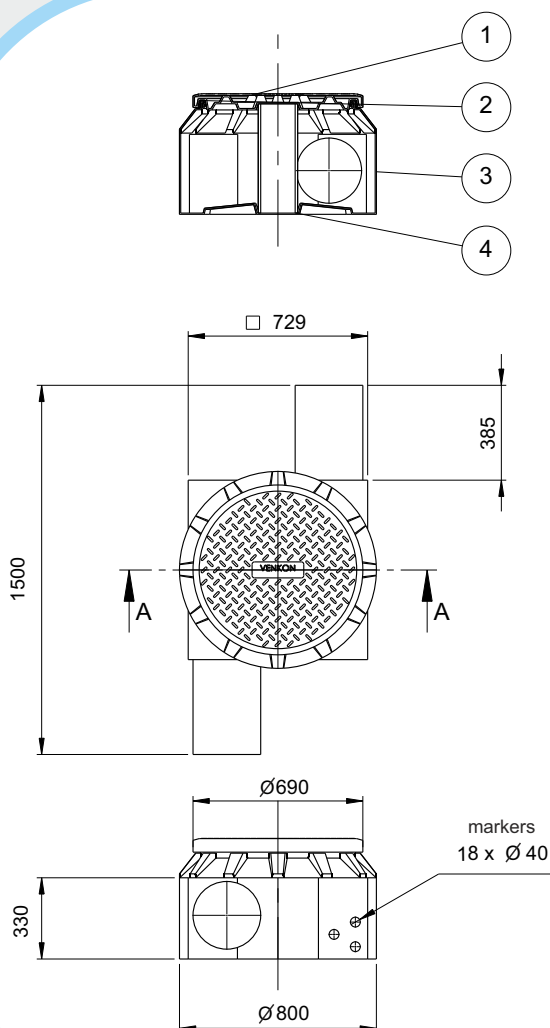

No.	Part name	Material
1	Cover	PE
2	Seal	rubber
3	Chamber	PE
4	Pillar	PE